

Modular Cooking Range Line EVO900 6 Drawer Refrigerated Base (R290)

ITEM # _____

MODEL # _____

NAME # _____

SIS # _____

AIA # _____



392600 (Z9TTBECOMKN)

Refrigerated base with 6
drawers, -2/+10 C - R290

Short Form Specification

Item No. _____

Refrigerated base with 6 drawers. Built-in refrigerator compressor unit. Can operate over the temperature range of -2°C to 10 °C. Exterior panels in stainless steel. To be installed below other EVO900 top units. Delivered with 50 mm height adjustable feet.

Main Features

- Adjustable temperature range from -2 °C to +10 °C to suit meat, fish and dairy storage requirements.
- Anti-tilt runners accept GN 1/1 containers.
- Forced air circulation for rapid cooling and an even temperature distribution.
- Right angled side edges eliminate gaps and possible dirt traps between units.
- Unit can be easily installed below other 900 line top models.
- Defrosting and automatic evaporation of condense drain: the condense is automatically evaporated thanks to the electric resistance in the condense drain container.
- GN compliant.
- Designed for modular installation into the cooking block.

Construction

- Access to all components from the front.
- Built-in compressor to suit operating conditions.
- Exterior panels in Stainless steel with Scotch Brite finish to meet the highest hygiene standards.
- Unit delivered with 150 mm height adjustable feet in Stainless steel. Feet can be extended up to 250 mm.

Sustainability

- CFC and HCFC free (highly ecological refrigerant type: R290).

Optional Accessories

- Flanged feet kit PNC 206136
- Frontal kicking strip for concrete installation, 1600 mm PNC 206152
- Frontal kicking strip, 1600 mm PNC 206179
- Kit 3 base support for wheels PNC 206430
- Kit 6 wheels - 3 swivelling with brake PNC 206432

APPROVAL: _____

Front

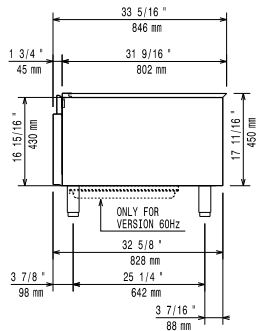

Side

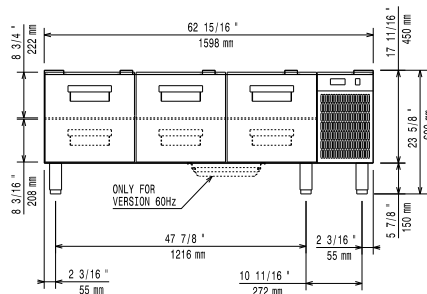

EI = Electrical inlet (power)

Top

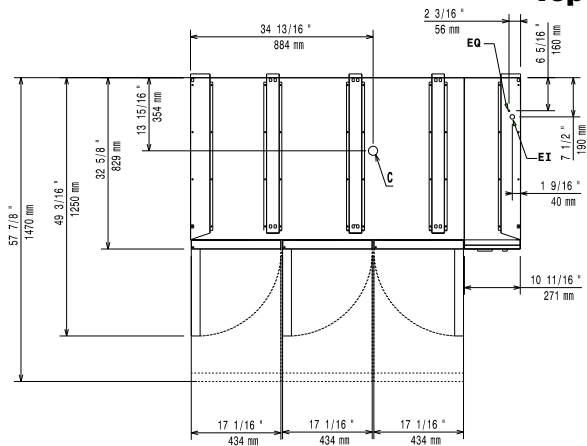

Electric

Supply voltage:	220-230 V/1N ph/50 Hz
Electrical power max.:	0.44 kW
Total Watts:	0.44 kW

Key Information:

External dimensions, Width:	1600 mm
External dimensions, Depth:	830 mm
External dimensions, Height:	600 mm
Net weight:	110 kg
Shipping weight:	157 kg
Shipping height:	780 mm
Shipping width:	950 mm
Shipping depth:	1650 mm
Shipping volume:	1.22 m ³
Gross capacity:	240 lt

Sustainability

Refrigerant type:	R290
Refrigerant weight:	85 g